

Wartung
Maintenance
Entretien
Manutenzione
Mantenimiento

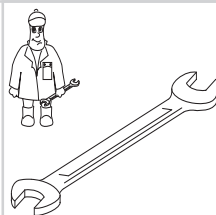

	Pos.	Menge ²⁾ Quantity Quantité Quantità Cantidad	Bestell-Nr. Ident No. No. Identification No. Identificazione No. de pedido	Bezeichnung Description Designation Designazione Descripción
U 4.190	□	1	549000 26400	Dichtungssatz, Complete set of seals, Jeu de joints, Kit di guarnizioni, Junta Completa
	5	SATZ (KIT)	900506 00003	Schieber, Rotor Vane, Palette, Silenciador
	83	2	965415 00000	Luftentölelement, Oil separating element, Element separation huile, Cartuccia separatore olio, Elemento de desaceitar de aire

²⁾ erforderliche Bestellmenge / necessary order quantity / quantité nécessaire / quantità di ordinazione necessari / cantidad necesario

Ersatzteilliste
Spare parts list
Liste de pièces de rechange
Listino pezzi di ricambio
Lista de piezas de recambio
Lista de peças sobresselentes
Reserveonderdelenlijst
Reservdelistsite
Reservdelistsita

Reservdelistsite
Varaosaluettelo
Wykaz części zamiennych
Seznam náhradních dílů
Tartalékalkatrész lista
Κατάλογος ανταλλακτικών
Перечень запасных частей
备用零件目录
スペアパーツリスト

U 4.190



280093000000 06/2010

Index-E



SERVICE

Made in Germany

BECKER Baujahr/year XXXX

D-42279 Wuppertal No. E-XXXXXXXXXX

Typ U 4.190-XX

Drehzahl / speed XXXX min⁻¹

Leistungsbedarf motor power required XXXX kW

Saugvermögen inlet capacity XXXX m³/h

Saugdruck / vacuum XXXX mbar

Index Option

Service:

Tel: +49 (0)202 697-1191

Fax: +49 (0)202 64 44 74

E-Mail: info@becker-international.com

 www.becker-international.com



U 4.190

Pos.	Bestell Nr.	Beschreibung	
□	549000 26400	DICHTUNGSSATZ ¹⁾	
1	000100 26400	GEHÄUSE	
3	020000 26400	KOLBEN	
5	900506 00003	SCHIEBER, KUNSTSTOFF (SATZ)	
7	917611 00000	LAGERDICHTRING	
8	911472 00000	DISTANZSCHEIBE	
9	906662 00000	WÄLZLAGER 6207 DIN 625	
10	906574 00000	WELLENDICHTRING	
11	912821 00000	VERSCHLUSSDECKEL	
12	001100 26400	LAGERDECKEL	
14	945319 00000	INNENSECHSKANTSCHRAUBE	
15	000800 26400	SEITENDECKEL MIT LATERNE	
16	000700 26400	SEITENDECKEL	
17	912871 00000	VERSCHLUSS-SCHRAUBE	
18	902108 00000	KUPPLUNGSHÄLFTE	
19	902210 00000	KUPPLUNGSSCHEIBE	
21	945331 00000	INNENSECHSKANTSCHRAUBE	
22	948742 00000	PASSKERBSTIFT	
24	947733 00000	PASSFEDER	
28	952008 00000	SPANNHÜLSE	
30	502301 26400	VENTILATOR MIT NABE	
31	947732 00000	PASSFEDER	
32	945270 00000	WELLENENDSCHRAUBE	
33	949409 00000	UNTERLEGSCHEIBE	
41	537501 26400	RÜCKSCHLAGVENTIL, KOMPL.	
46	008002 26400	SIEB	
47	945371 00000	INNENSECHSKANTSCHRAUBE	
49	951602 00000	RINGMÜTTER	
50	946969 00000	STIFTSCHRAUBE	
52	951228 02000	VERSCHLUSS-SCHRAUBE	
61	002403 26400	ABSCHIEDERGEHÄUSE	
62	951221 00000	VERSCHLUSS-SCHRAUBE	
64	001702 26400	ÖLBEHÄLTER-DECKEL	
67	003701 26400	DECKEL	
69	946968 00000	STIFTSCHRAUBE	
70	917107 00000	TELLERFEDER	
71	947105 00000	SECHSKANTMÜTTER	
74	305800 02000	ÜBERWURFMÜTTER	
76	727501 99628	ABBLASEVENTIL	
83	965415 00000	LUFTEHTÖLELEMENT (2x) ²⁾	
89	921500 50000	HANDGRIFF	
90	013300 26400	PRALLBLECH	
91	945318 00000	INNENSECHSKANTSCHRAUBE	
93	945226 00000	SECHSKANTSCHRAUBE	
94	867800 99559	SCHWIMMER	
95	003300 10700	DÜSE	
97	912300 00000	ANSCHLUSS-SCHRAUBE	
101	506000 26400	GROBABSCHIEDER, KOMPLETT	
104	008001 26400	SIEB	
112	003703 26400	DECKEL	
119	907309 00000	ÖLSCHAUGLAS	
120	916800 10000	SCHRAUBDECKEL	
124	947104 00000	SECHSKANTMÜTTER	
125	948504 00000	FEDERING	
126	951001 02000	STIFTSCHRAUBE	
128	951003 02000	STIFTSCHRAUBE	
130	945383 00000	INNENSECHSKANTSCHRAUBE	
131	945330 00000	INNENSECHSKANTSCHRAUBE	



U 4.190

Pos.	Bestell Nr.	Beschreibung	
132	945363 00000	INNENSECHSKANTSCHRAUBE	
133	945321 00000	INNENSECHSKANTSCHRAUBE	
134	945324 00000	INNENSECHSKANTSCHRAUBE	
135	951220 00000	VERSCHLUSS-SCHRAUBE	
141	012206 26400	LEITUNG	
142	012207 26400	LEITUNG	
143	012202 26400	ÖLRÜCKFÜHRLEITUNG	
148	948402 00000	HOHLSCHRAUBE	
151	012203 26400	ÖLSAUGLEITUNG	
152	009400 19000	KUGELSTÜCKSCHRAUBE	
154	012900 19000	VERSCHLUSS-SCHRAUBE	
156	912306 00000	ANSCHLUSS-SCHRAUBE	
157	960201 26400	KÜHLER	
159	012205 26400	LEITUNG	
181	018301 26400	HAUBE	
183	902100 21900	MOTORKUPPLUNG, Ø38MM (WB-MOT.) ³⁾	
184	945237 00000	SECHSKANTSCHRAUBE	
185	947506 00000	UNTERLEGSCHEIBE	
186	945349 00000	INNENSECHSKANTSCHRAUBE (WB-MOT.) ³⁾	
187	568100 26400	STÜTZE	
188	949408 00000	U-SCHEIBE	
190	001800 20000	WELLENABSCHLUSS-SCHRAUBE	
193	949203 00000	ZAHNSCHEIBE	
195	037900 26400	ZWISCHENFLANSCH (WB-MOT.) ³⁾	
197	741302 00000	GUMMIPUFFER	
198	945634 00000	GEWINDESTIFT	
218	902108 00000	MOTORKUPPLUNG, Ø28MM	
233	537500 10700	VENTIL, KOMPL.	
282	741103 99682	NIVEAUGEGER - OPTIONAL	
313	902100 21300	MOTORKUPPLUNG (US)	
314	945236 00000	SECHSKANTSCHRAUBE (US)	
316	037900 12900	ZWISCHENFLANSCH (US)	

¹⁾ Dichtungssatz - 54900026400

- Pos.: 13, 25, 26, 37, 38, 44, 53, 63, 77, 79, 80, 118, 121, 129, 136, 149, 153

²⁾ erforderliche Bestellmenge / Wartung

³⁾ Δ190-255V / Y330-440V 50Hz

Δ190-290V / Y330-500V 60Hz

OPTIONAL

U 4.190 SA/K -51 Sonderausführung - mit Ölbadheizung, Niveau-Geber und Thermostat
-54 Sonderausführung - mit zusätzlicher Ölablassbohrung

U 4.190 F/K -51 Sonderausführung - mit Ölbadheizung, Niveau-Geber und Thermostat

Abweichende Positionen zum Standardgerät - siehe Anhang



U 4.190

Pos.	Ident No.	Description
□	549000 26400	GASKET SET ¹⁾
1	000100 26400	PUMP BODY
3	020000 26400	ROTOR
5	900506 00003	ROTOR VANE IN PLASTIC (KIT)
7	917611 00000	BEARING SEALING WASHER
8	911472 00000	DISTANCE DISC
9	906662 00000	BEARING 6207 DIN 625
10	906574 00000	SHAFT SEALING RING
11	912821 00000	CAP
12	001100 26400	BEARING COVER
14	945319 00000	SOCKET HEAD SCREW
15	000800 26400	LID WITH FLANGE
16	000700 26400	LID
17	912871 00000	LOCKING SCREW
18	902108 00000	COUPLING
19	902210 00000	COUPLING DISC
21	945331 00000	SOCKET HEAD SCREW
22	948742 00000	STRAIGHT PIN
24	947733 00000	KEY
28	952008 00000	LOCATING PEG
30	502301 26400	FAN
31	947732 00000	KEY
32	945270 00000	SHAFT END BOLD
33	949409 00000	WASHER
41	537501 26400	NON RETURN VALVE, ENTIRE
46	008002 26400	SIEVE
47	945371 00000	SOCKET HEAD SCREW
49	951602 00000	RING UNIT
50	946969 00000	STUD
52	951228 02000	LOCKING SCREW
61	002403 26400	HOUSING FOR OIL SEPARATION
62	951221 00000	LOCKING SCREW
64	001702 26400	OIL TANK COVER
67	003701 26400	COVER
69	946968 00000	STUD
70	917107 00000	SPRING COLLAR
71	947105 00000	HEX.NUT
74	305800 02000	COUPLING NUT
76	727501 99628	BLOW OFF VALVE
83	965415 00000	OIL SEPARATION ELEMENT (2x) ²⁾
89	921500 50000	HANDLE
90	013300 26400	METAL FILTER
91	945318 00000	SOCKET HEAD SCREW
93	945226 00000	HEX. HEAD SCREW
94	867800 99559	FLOAT
95	003300 10700	NOZZLE
97	912300 00000	CONNECTING SCREW
101	506000 26400	COARSE SEPARATOR
104	008001 26400	SIEVE
112	003703 26400	COVER
119	907309 00000	OIL SIGHT GLASS
120	916800 10000	COVER
124	947104 00000	HEX.NUT
125	948504 00000	SPRING WASHER
126	951001 02000	STUD
128	951003 02000	STUD
130	945383 00000	SOCKET HEAD SCREW
131	945330 00000	SOCKET HEAD SCREW



U 4.190

Pos.	Ident No.	Description
132	945363 00000	SOCKET HEAD SCREW
133	945321 00000	SOCKET HEAD SCREW
134	945324 00000	SOCKET HEAD SCREW
135	951220 00000	LOCKING SCREW
141	012206 26400	PIPE
142	012207 26400	PIPE
143	012202 26400	OIL RETURN PIPE
148	948402 00000	HOLLOW SCREW
151	012203 26400	OIL SUCTION PIPE
152	009400 19000	HOLLOW HOLDING SCREW
154	012900 19000	LOCKING SCREW
156	912306 00000	CONNECTING SCREW
157	960201 26400	COOLER
159	012205 26400	PIPE
181	018301 26400	PROTECTING HOOD
183	902100 21900	COUPLING MOTOR SIDE, Ø38MM (WB-MOT.) ³⁾
184	945237 00000	HEX-HEAD SCREW
185	947506 00000	WASHER
186	945349 00000	SOCKET HEAD SCREW (WB-MOT.) ³⁾
187	568100 26400	SUPPORT PILLAR
188	949408 00000	WASHER
190	001800 20000	SCREW
193	949203 00000	TOOTHED SPRING WASHER
195	037900 26400	INTERMEDIATE FLANGE (WB-MOT.) ³⁾
197	741302 00000	RUBBER BUFFER
198	945634 00000	THREADED PIN
218	902108 00000	COUPLING MOTOR SIDE, Ø28MM
233	537500 10700	VALVE, ENTIRE
282	741103 99682	OIL LEVEL CONTROL - OPTIONAL
313	902100 21300	COUPLING MOTOR SIDE (US)
314	945236 00000	HEX-HEAD SCREW (US)
316	037900 12900	INTERMEDIATE FLANGE (US)



¹⁾ Set of seals - 54900026400
 - Pos.: 13, 25, 26, 37, 38, 44, 53, 63, 77, 79, 80, 118, 121, 129, 136, 149, 153
²⁾ necessary order quantity / maintenance
³⁾ Δ190-255V / Y330-440V 50Hz
 Δ190-290V / Y330-500V 60Hz

OPTIONAL

U 4.190 SA/K -51	Special design – with oil bath heating, level transmitter and heat valve
-54	Special design – with additional oil draining bore hole
U 4.190 F/K -51	Special design – with oil bath heating, level transmitter and heat valve

Items different from standard appliance see appendix (back of drawing)



U 4.190

Pos.	No. Identification	Designation
□	549000 26400	JEU DE JOINTS ¹⁾
1	000100 26400	CORP DE POMPE
3	020000 26400	PISTON
5	900506 00003	PALETTE ON PLASTIQUE (KIT)
7	917611 00000	RONDELLE D'ETANCHEITE DU ROULEMENT
8	911472 00000	DISQUE AJUSTAGE
9	906662 00000	ROULEMENT 6207 DIN 625
10	906574 00000	BAGUE D'ETANCHEITE P.L'AXE
11	912821 00000	COUVERCLE
12	001100 26400	COUVERCLE DE ROULEMENTE
14	945319 00000	VIS HEXAGONALE INTERNE
15	000800 26400	COUVERCLE AVEC BRIDE
16	000700 26400	COUVERCLE
17	912871 00000	BOUCHON
18	902108 00000	ACCOUPLLEMENT
19	902210 00000	DISQUE D'ACCOUPLLEMENT
21	945331 00000	VIS HEXAGONALE INTERNE
22	948742 00000	GOUPILLE CYLINDRIQUE
24	947733 00000	CLAVETTE
28	952008 00000	DOVILLE DE ETRAGE
30	502301 26400	VENTILATEUR
31	947732 00000	CLAVETTE
32	945270 00000	VIS BOUT D'ARBRE
33	949409 00000	RONDELLE
41	537501 26400	SOUPAPE ANTI-RETOUR, ENTIER
46	008002 26400	FILTRE
47	945371 00000	VIS HEXAGONALE INTERNE
49	951602 00000	ECROU A ANNEAU
50	946969 00000	PRISONNIER
52	951228 02000	BOUCHON
61	002403 26400	CORP DE SEPARATEUR D'HUILE
62	951221 00000	BOUCHON
64	001702 26400	COUVERCLE RESERVOIR D'HUILE
67	003701 26400	COUVERCLE
69	946968 00000	PRISONNIER
70	917107 00000	RONDELLE À RESSORT
71	947105 00000	ECROU A 6 PANS
74	305800 02000	ECROU
76	727501 99628	SILENCIEUX
83	965415 00000	ELEMENT SEPARATION HUILE (2x) ²⁾
89	921500 50000	POIGNEE
90	013300 26400	FILTRE METALIQUE
91	945318 00000	VIS HEXAGONALE INTERNE
93	945226 00000	VIS HEXAGONALE
94	867800 99559	PIED CAOUTCHOVE
95	003300 10700	GICLEUR
97	912300 00000	VIS DE RACCORD
101	506000 26400	SEPARATEUR A GROS
104	008001 26400	FILTRE
112	003703 26400	COUVERCLE
119	907309 00000	VERRE REGARD
120	916800 10000	COUVERCLE
124	947104 00000	ECROU A 6PANS
125	948504 00000	ANNEAU-RESSORT
126	951001 02000	PRISONNIER
128	951003 02000	PRISONNIER
130	945383 00000	VIS HEXAGONALE INTERNE
131	945330 00000	VIS HEXAGONALE INTERNE



U 4.190

Pos.	No. Identification	Designation
132	945363 00000	VIS HEXAGONALE INTERNE
133	945321 00000	VIS HEXAGONALE INTERNE
134	945324 00000	VIS HEXAGONALE INTERNE
135	951220 00000	BOUCHON
141	012206 26400	TUYAU
142	012207 26400	TUYAU
143	012202 26400	TUYAU D'HUILE
148	948402 00000	VIS CREUSE
151	012203 26400	TUYAU D'HUILE
152	009400 19000	VIS CREUSE DE FIXATION
154	012900 19000	BUCHON
156	912306 00000	VIS DE RACCORD
157	960201 26400	REFROIDISSEUR
159	012205 26400	TUYAU
181	018301 26400	CARTER PROTECTEUR
183	902100 21900	ACCOUPLLEMENT MOTEUR, Ø38MM (WB-MOT.) ³⁾
184	945237 00000	VIS HEXAGONALE
185	947506 00000	RONDELLE
186	945349 00000	VIS HEXAGONALE INTERNE (WB-MOT.) ³⁾
187	568100 26400	SUPPORT INTERMEDIAIRE
188	949408 00000	RONDELLE
190	001800 20000	VIS
193	949203 00000	DENT DISQUE
195	037900 26400	BRIDE INTERMEDIAIRE (WB-MOT.) ³⁾
197	741302 00000	AMORTISSEUR EN CAOUTCHOUC
198	945634 00000	GOUPILLE FILETEE
218	902108 00000	ACCOUPLLEMENT MOTEUR, Ø28MM
233	537500 10700	SOUPAPE, ENTIER
282	741103 99682	INDICATEUR DE NIVEAU - EN OPTION
313	902100 21300	ACCOUPLLEMENT MOTEUR (US)
314	945236 00000	VIS HEXAGONALE (US)
316	037900 12900	BRIDE INTERMEDIAIRE (US)

¹⁾ Jeu de joints - 54900026400

- Pos.: 13, 25, 26, 37, 38, 44, 53, 63, 77, 79, 80, 118, 121, 129, 136, 149, 153

²⁾ quantité nécessaire / entretien³⁾ Δ190-255V / Y330-440V 50Hz

Δ190-290V / Y330-500V 60Hz

EN OPTION

U 4.190 SA/K -51 Exécution – avec chauffage du bain d'huile, capteur de niveau et thermostat
-54 Exécution spéciale – avec trou de vidange d'huile

U 4.190 F/K -51 Exécution – avec chauffage du bain d'huile, capteur de niveau et thermostat

Articles divergents vis-à-vis de l'appareil standard, voir annexe (dos du dessin / du plan) 



U 4.190

Pos.	No. Identificazione	Designazione
□	549000 26400	KIT GUARNIZIONI ¹⁾
1	000100 26400	CARCASSA
3	020000 26400	ROTORE
5	900506 00003	PALETTE IN PLASTICA (KIT)
7	917611 00000	ANELLO DI TENUTA DEL CUSCINETTO
8	911472 00000	DISCO DISTANZA
9	906662 00000	CUSCINETTO 6207 DIN 625
10	906574 00000	GUARNIZIONE PER L'ALBERO
11	912821 00000	COPERCHIO
12	001100 26400	COPERCHIO CUSCINETTO
14	945319 00000	VITE ESAGONALE INTERNA
15	000800 26400	COPERCHIO CON FLANGIA
16	000700 26400	COPERCHIO
17	912871 00000	VITE DI CHIUSURA
18	902108 00000	GIUNTO
19	902210 00000	DISCO GIUNTO
21	945331 00000	VITE ESAGONALE INTERNA
22	948742 00000	PERNO
24	947733 00000	CHIAVETTA
28	952008 00000	SPINE DI RISCONTRO
30	502301 26400	VENTILATORE
31	947732 00000	CHIAVETTA
32	945270 00000	VITE DI CHIUSURA ALBERO
33	949409 00000	RONDELLA
41	537501 26400	VALVOLA NON RITORNO, INTERO
46	008002 26400	FILTRO
47	945371 00000	VITE ESAGONALE INTERNA
49	951602 00000	GOLFARE CON FORO FILETTATO
50	946969 00000	L'ASTA A VITE
52	951228 02000	VITE DI CHIUSURA
61	002403 26400	CARCASSA SEPARATORE OLIO
62	951221 00000	VITE DI CHIUSURA
64	001702 26400	COPERCHIO SERBATOIO OLIO
67	003701 26400	COPERCHIO
69	946968 00000	L'ASTA A VITE
70	917107 00000	RONDELLA A MOLLA
71	947105 00000	DADO ESAGONALE
74	305800 02000	DADO DI RISVOLTO
76	727501 99628	SILENZIATORE
83	965415 00000	CARTUCCIA SEPARATORE OLIO (2x) ²⁾
89	921500 50000	MANETTA
90	013300 26400	FILTRO METALICO
91	945318 00000	VITE ESAGONALE INTERNA
93	945226 00000	VITE ESAGONALE
94	867800 99559	GALLEGGIANTE
95	003300 10700	UGELLO
97	912300 00000	ATTACO FILETTATO
101	506000 26400	SEPARATORE GROSSOLANO
104	008001 26400	FILTRO
112	003703 26400	COPERCHIO
119	907309 00000	SPIA LIVELLO OLIO
120	916800 10000	COPERCHIO
124	947104 00000	DADO ESAGONALE
125	948504 00000	ANELLO A MOLLA
126	951001 02000	L'ASTA A VITE
128	951003 02000	L'ASTA A VITE
130	945383 00000	VITE ESAGONALE INTERNA
131	945330 00000	VITE ESAGONALE INTERNA



U 4.190

Pos.	No. Identificazione	Designazione
132	945363 00000	VITE ESAGONALE INTERNA
133	945321 00000	VITE ESAGONALE INTERNA
134	945324 00000	VITE ESAGONALE INTERNA
135	951220 00000	VITE DI CHIUSURA
141	012206 26400	CONDOTTO
142	012207 26400	CONDOTTO
143	012202 26400	CONDOTTO OLIO
148	948402 00000	VITE ESAGONALE
151	012203 26400	CONDOTTO OLIO
152	009400 19000	VITE PASSAGGIO OLIO
154	012900 19000	VITE DI CHIUSURA
156	912306 00000	ATTACO FILETTATO
157	960201 26400	RAFFREDDATORE
159	012205 26400	CONDOTTO
181	018301 26400	CARTER DI PROTEZIONE
183	902100 21900	GIUNTO MOTORE, Ø38MM (WB-MOT.) ³⁾
184	945237 00000	VITE ESAGONALE
185	947506 00000	RONDELLA
186	945349 00000	VITE ESAGONALE INTERNA (WB-MOT.) ³⁾
187	568100 26400	SUPPORTO
188	949408 00000	RONDELLA
190	001800 20000	VITE
193	949203 00000	DISCO A DENTE
195	037900 26400	FLANGE INTERMEDIA (WB-MOT.) ³⁾
197	741302 00000	AMMORTIZZATORE IN GOMMA
198	945634 00000	SPINA FILETTATURA
218	902108 00000	GIUNTO MOTORE, Ø28MM
233	537500 10700	VALVOLA, INTERO
282	741103 99682	SONDA D'OLIO - OPZIONALE
313	902100 21300	GIUNTO MOTORE (US)
314	945236 00000	VITE ESAGONALE (US)
316	037900 12900	FLANGE INTERMEDIA (US)

¹⁾ Serie di guarnizione - 54900026400

- Pos.: 13, 25, 26, 37, 38, 44, 53, 63, 77, 79, 80, 118, 121, 129, 136, 149, 153

²⁾ quantità di ordinazione necessari / manutenzione

³⁾ Δ190-255V / Y330-440V 50Hz

Δ190-290V / Y330-500V 60Hz

OPTIONALE

U 4.190 SA/K -51
-54

Modello - con riscaldamento a bagno d'olio, indicatore di livello e termostato
Modello speciale - con faro di scarico dell'olio aggiuntivo

U 4.190 F/K -51

Modello - con riscaldamento a bagno d'olio, indicatore di livello e termostato

Vedere allegato (retro del disegno) per le posizioni divergenti dall'apparecchio



Pos.	No. De pedido	Descripción
□	549000 26400	JUEGO DE JUNTA ¹⁾
1	000100 26400	CARCASA
3	020000 26400	ÉMBOLO
5	900506 00003	EMPUJADOR DE PLÁSTICO (KIT)
7	917611 00000	ANILLO DE COJINETE DE JUNTA
8	911472 00000	ARANDELA DISTANCIADORA
9	906662 00000	COJINETE DE RODAMIENTO 6207 DIN 625
10	906574 00000	ANILLO DE JUNTA DE ÁRBOL
11	912821 00000	TAPA DE CIERRE
12	001100 26400	TAPA DE COJINETE
14	945319 00000	TORNILLO HEXAGONAL INTERIOR
15	000800 26400	TAPA LATERAL CONFAROL
16	000700 26400	TAPA LATERAL
17	912871 00000	TORNILLO DE CIERRE
18	902108 00000	MITAD DE ACOPLAMIENTO
19	902210 00000	DISCO DE ACOPLAMIENTO
21	945331 00000	TORNILLO HEXAGONAL INTERIOR
22	948742 00000	PASADOR ENTALLADO DE AJUSTE
24	947733 00000	LENGÜETA DE AJUSTE
28	952008 00000	CASQUILLO TENSOR
30	502301 26400	VENTILADOR CON CUBO
31	947732 00000	LENGÜETA DE AJUSTE
32	945270 00000	TORNILLO TERMINAL DE ÁRBOL
33	949409 00000	ARANDELA
41	537501 26400	VÁLVULA ANTIRRETORNO COMPLETA
46	008002 26400	CRIBA
47	945371 00000	TORNILLO HEXAGONAL INTERIOR
49	951602 00000	TUERCA DE CÁNCAMO
50	946969 00000	ESPÁRRAGO
52	951228 02000	TORNILLO DE CIERRE
61	002403 26400	CARCASA SEPARADORA
62	951221 00000	TORNILLO DE CIERRE
64	001702 26400	TAPA DE RECIPIENTE DE ACEITE
67	003701 26400	TAPA
69	946968 00000	ESPÁRRAGO
70	917107 00000	ARANDELA DE APOYO DEL RESORTE
71	947105 00000	TUERCA HEXAGONAL
74	305800 02000	SOBRETUERCA
76	727501 99628	VÁLVULA DE BARRIDO
83	965415 00000	ELEMENTO DE DESACEITAR DE AIRE (2x) ²⁾
89	921500 50000	EMPUÑADURA
90	013300 26400	CHAPA DE REBOTE
91	945318 00000	TORNILLO HEXAGONAL INTERIOR
93	945226 00000	TORNILLO DE CABEZA HEXAGONAL
94	867800 99559	FLOTADOR
95	003300 10700	TOBERA
97	912300 00000	TORNILLO DE EMPALME
101	506000 26400	SEPARADOR DE SÓLIDOS GRUESOS COMPLETO
104	008001 26400	CRIBA
112	003703 26400	TAPA
119	907309 00000	CRISTAL MIRILLA DE ACEITE
120	916800 10000	TAPA ROSCADA
124	947104 00000	TUERCA HEXAGONAL
125	948504 00000	ARANDELA DE MUELLE
126	951001 02000	ESPÁRRAGO
128	951003 02000	ESPÁRRAGO
130	945383 00000	TORNILLO HEXAGONAL INTERIOR
131	945330 00000	TORNILLO HEXAGONAL INTERIOR

Pos.	No. De pedido	Descripción
132	945363 00000	TORNILLO HEXAGONAL INTERIOR
133	945321 00000	TORNILLO HEXAGONAL INTERIOR
134	945324 00000	TORNILLO HEXAGONAL INTERIOR
135	951220 00000	TORNILLO DE CIERRE
141	012206 26400	CONDUCTO
142	012207 26400	CONDUCTO
143	012202 26400	CONDUCTO DE RETROALIMENTACIÓN DE ACEITE
148	948402 00000	TORNILLO HUECO
151	012203 26400	CONDUCTO DE ASPIRACIÓN DE ACEITE
152	009400 19000	TORNILLO DE PIEZA ESFÉRICA
154	012900 19000	TORNILLO DE CIERRE
156	912306 00000	TORNILLO DE EMPALME
157	960201 26400	REFRIGERADOR
159	012205 26400	CONDUCTO
181	018301 26400	SOMBRETERE
183	902100 21900	ACOPLAMIENTO DE MOTOR, Ø38MM (WB-MOT.) ³⁾
184	945237 00000	TORNILLO DE CABEZA HEXAGONAL
185	947506 00000	ARANDELA
186	945349 00000	TORNILLO HEXAGONAL INTERIOR (WB-MOT.) ³⁾
187	568100 26400	APOYO
188	949408 00000	ARANDELA
190	001800 20000	TORNILLO TERMINAL DE ÁRBOL
193	949203 00000	POLEA DENTADA
195	037900 26400	BRIDA INTERMEDIA (WB-MOT.) ³⁾
197	741302 00000	AMORTIGUADOR DE GOMA
198	945634 00000	VARILLA ROSCADA
218	902108 00000	ACOPLAMIENTO DE MOTOR, Ø28MM
233	537500 10700	VÁLVULA COMPLETA
282	741103 99682	GENERADOR DE NIVEL - OPCIONAL
313	902100 21300	ACOPLAMIENTO DE MOTOR (US)
314	945236 00000	TORNILLO DE CABEZA HEXAGONAL (US)
316	037900 12900	BRIDA INTERMEDIA (US)

¹⁾ Junta completa - 54900026400

- Pos.: 13, 25, 26, 37, 38, 44, 53, 63, 77, 79, 80, 118, 121, 129, 136, 149, 153

²⁾ cantidad necesario / mantenimiento

³⁾ Δ190-255V / Y330-440V 50Hz

Δ190-290V / Y330-500V 60Hz

OPCIONAL
U 4.190 SA/K -51
-54

Versión – con calefacción de baño de aceite, codificador de nivel y termostato

Versión especial – con perforación de salida de aceite adicional

U 4.190 F/K -51

Versión – con calefacción de baño de aceite, codificador de nivel y termostato

Para posiciones que derivan del aparato standard véase apéndice (lado trasero del )

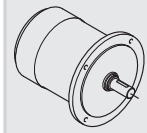

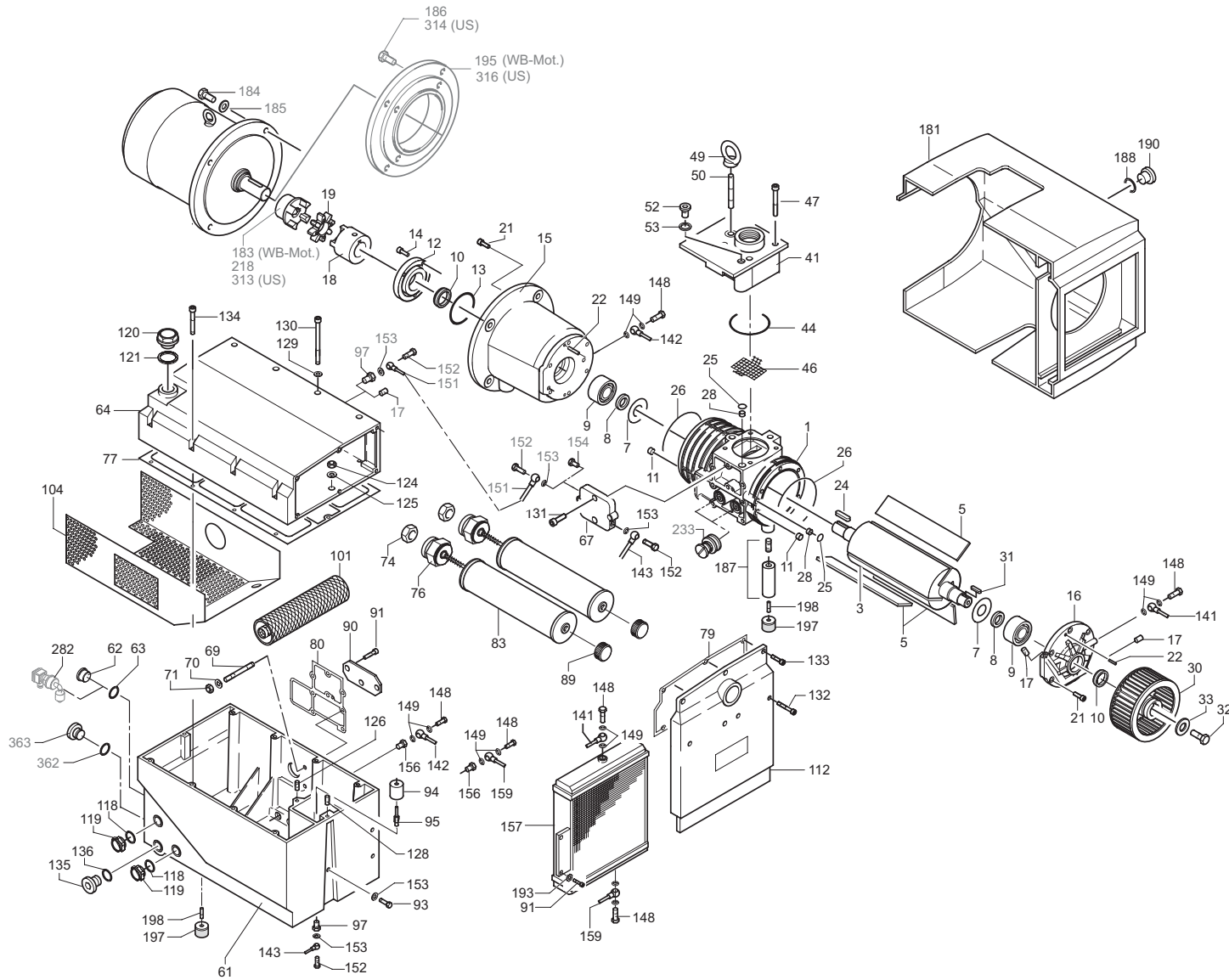
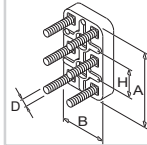
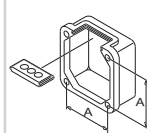
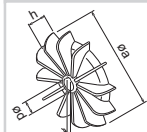
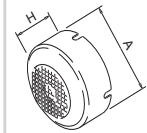

SERVICE



standard

U 4.190 F/K
U 4.190 SA/K

optional
en option
opcionale
opcional

optional en option optionale opcional 	Variante(n) Modifications Variantes	Pos ⁴⁾	Bestell Nr. / Ident No. / No. Identification / No. Identificazione / No. De pedido		Beschreibung / Description / Designation / Designazione / Desripcion	
						
U 4.190 SA/XX U 4.190 F/XX	U 4.190 SA/K - 51 U 4.190 F/K - 51	61		002403-26400	ÖLABSCHEIDERGEHÄUSE / HOUSING FOR OIL SEPARATION / CARCASSE POUR SEPARATION D'HUILLE / CARCASSA SEPARATORE OLIO / CARCASA SEPARADORA DE ACEITE VERSCHLUSSSCHRAUBE / LOCKING SCREW / BOUCHON / VITE DI CHIUSURA / TORNILLO DE CIERRE NIVEAUGEBER / LEVEL TRANSMITTER / CAPTEUR DE NIVEAU / INDICATORE DI LIVELLO / CODIFICADOR DE NIVEL ÖLABSCHEIDERGEHÄUSE / HOUSING FOR OIL SEPARATION / CARCASSE POUR SEPARATION D'HUILLE / CARCASSA SEPARATORE OLIO / CARCASA SEPARADORA DE ACEITE ROHRHEIZKÖRPER / PIPE HEATER / CORPS DE CHAUFFE / SCALDIGLIA / CALEFACTOR TUBULAR TEMPERATUR-WÄCHTER / THERMOSTAT / THERMOSTAT / INTERRUPTORE TERMICO / TERMOSTATO DICHRING / SEALING RING / JOINT / ANELLO / ANILLO	
		62		951221-00000		
		282	741103 99682			
		340	002404 26400			
		341	960202 26400			
		342	943400 70000			
		343	948029 00000			
		U 4.190 SA/K - 54	61			002403-26400
			361	002405 26400		
			362	948013 00000		
		363	951220 00000			

⁴⁾ variantenabhängige Bauteile / variant-dependent components / composants variante-dependantes / componenti variante-dispendenti / componentes variante-dependientes

 standard